



**GEBRUIKSAANWIJZING
GIRAF**

**WWF
DIER
&
STICKERS**



**100%
COMPATIBEL
MET GROTE
MERKEN**

De FabBrix™-onderdelen zijn van hout gemaakt. Als de blokken nat worden of als de luchtvochtigheid hoog is, kunnen ze onbruikbaar worden. Belangrijke opmerking: door de zeer nauwkeurige houtzaagtechnieken kunnen de blokken in eerste instantie een strakke pasvorm hebben. Dit kan het moeilijker maken om ze op elkaar te klikken en weer los te maken. Dit zal na een paar keer gebruik niet meer het geval zijn. Maak de blokken niet nat. Houd uit de buurt van water en vuur.
WAARSCHUWING: VERSTIKKINGSGEVAAR - kleine onderdelen.
Niet geschikt voor kinderen jonger dan 3 jaar.

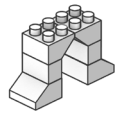
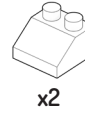
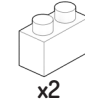

1

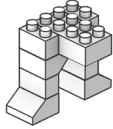
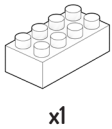
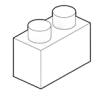

2

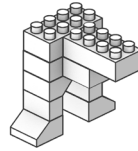
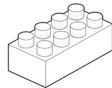

3

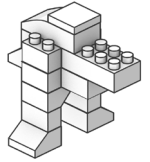
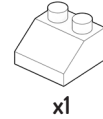
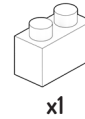
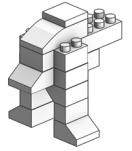
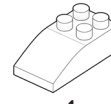

4

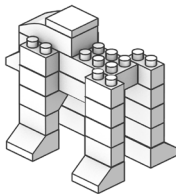
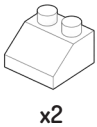

5

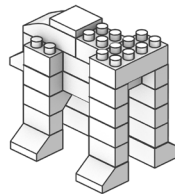
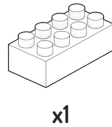

6

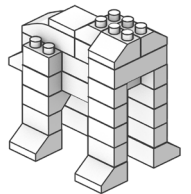

7

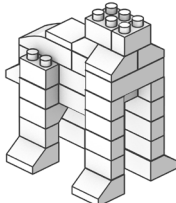
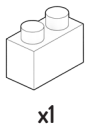

8

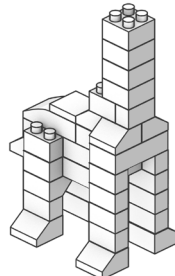

9

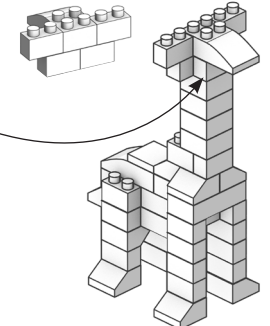
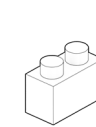

10

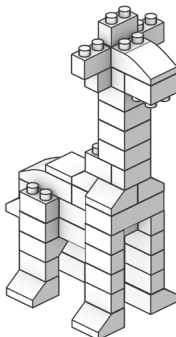
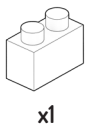

11

contact@loop-toys.com
Loop Toys Ltd
3/F, Jonsim Place, 228, Queen's Road East
Wanchai - Hong Kong

Geproduceerd en Chine.
© Loop Toys 2018. Alle rechten voorbehouden.
De logo's van FabBrix en Loop Toys zijn geregistreerde handelsmerken van Loop Toys.
IN OVEREENSTEMMING MET DE VEILIGHEIDSVORSCHRIFTEN VAN ASTM F963 & EN71.
Bewaar dit karton voor toekomstig gebruik.

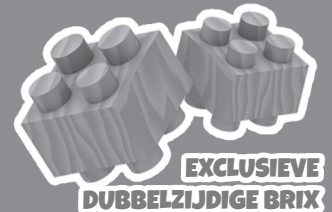



**100%
COMPATIBLE
AVEC LES GRANDES
MARQUES**



Les pièces FabBrix™ sont en bois. En cas d'immersion dans l'eau ou en présence d'humidité élevée dans l'air, la fonction des briques peut être altérée. Avis important : à cause de techniques de coupe du bois de haute précision, les briques peuvent être un peu étroites au départ. Il peut être plus difficile de les empiler et séparer. Ce phénomène disparaîtra au bout de quelques utilisations. Ne pas les mouiller. Tenir à l'écart de l'eau et du feu. ATTENTION : RISQUE D'ÉTOUFFEMENT - Pièces de petite taille. Ne convient pas aux enfants de moins de 3 ans.

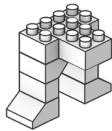
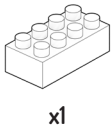
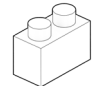
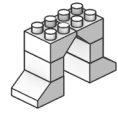
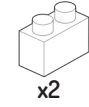
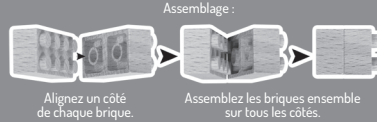

2

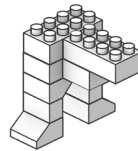
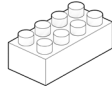

3

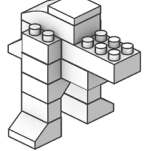
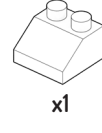
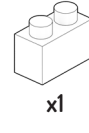
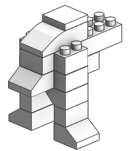
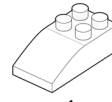

4

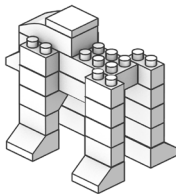
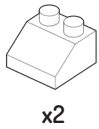

5

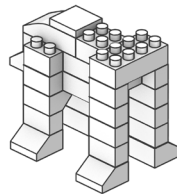
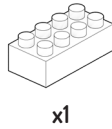

6

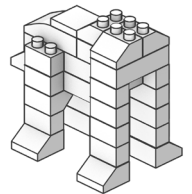
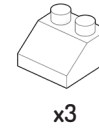

7

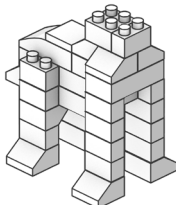
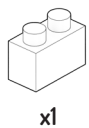

8

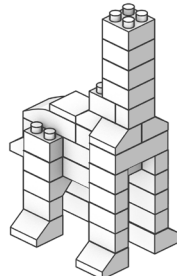

9

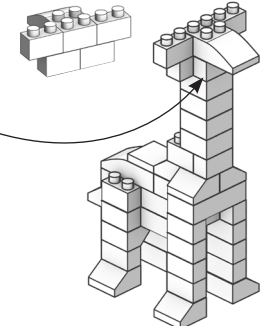
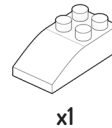
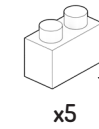

10

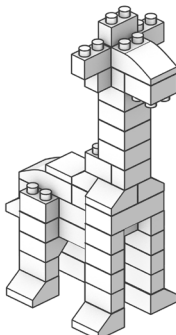
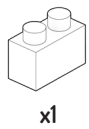

11

contact@loop-toys.com
Loop Toys Ltd
3/F, Jonsim Place, 228, Queen's Road East
Wanchai - Hong Kong

Fabriqué en Chine.
© Loop Toys 2018. Tous droits réservés.
Les logos FabBrix et Loop Toys sont des marques déposées de Loop Toys.
CONFORME AUX EXIGENCES DE SÉCURITÉ DES NORMES ASTM F963 ET EN71.
Conservez ce carton pour une consultation ultérieure.

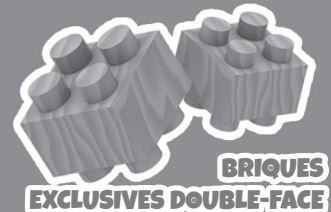

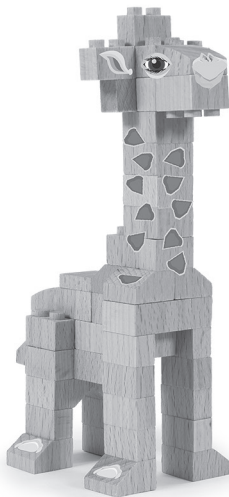

100%
COMPATIBLE
CON LAS PRINCIPALES
MARCAS

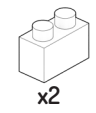

x2

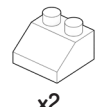

x2

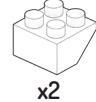

x2

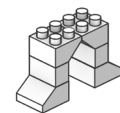

Para encajarlos:



Alinee un lado
de cada bloque.

Una los bloques a lo largo
de todos los lados.

Las piezas FabBrix™ están hechas de madera. Si se colocan en agua o hay mucha humedad en el aire, los bloques pueden perder o alterar su función. Aviso importante: debido a las técnicas de corte de la madera de alta precisión, al principio los bloques pueden estar firmemente encajados. Esto puede dificultar la conexión y desconexión. Esto desaparecerá después de algunos usos. No los moje. Mantener alejado del agua y el fuego. ADVERTENCIA: PELIGRO DE ASFIXIA - Piezas pequeñas. No apto para menores de 3 años.

2



x2

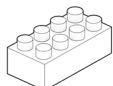

x1

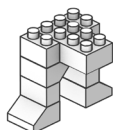

3

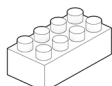

x2

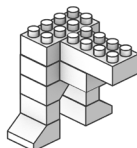

4

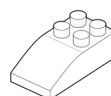

x1



x1

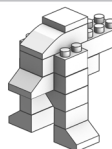

x1

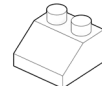

x1

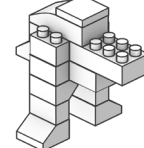

5



x8



x2

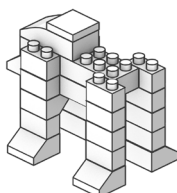

6



x1

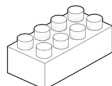

x1

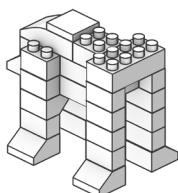

7

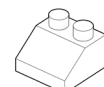

x3

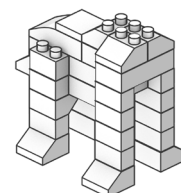

8



x1



x1

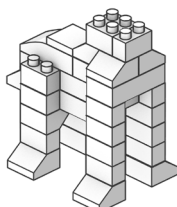

9



x4

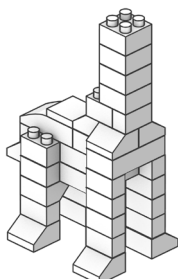

10



x5

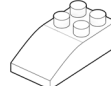

x1

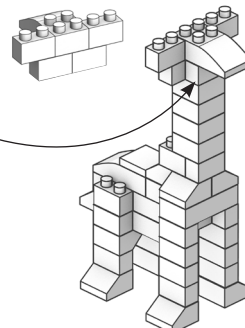

11



x1



x1

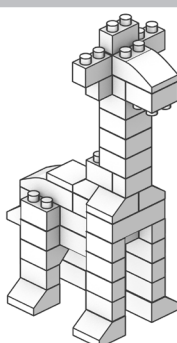

contact@loop-toys.com
Loop Toys Ltd
3/F, Jonsim Place, 228, Queen's Road East
Wanchai - Hong Kong

Fabricado en China.
© Loop Toys 2018. Todos los derechos reservados.
Los logotipos de FabBrix y Loop Toys son marcas comerciales registradas de Loop Toys.
CUMPLE LOS REQUISITOS DE SEGURIDAD DE ASTM F963 & EN71.
Conserve esta caja para referencia futura.



PIEZA
DE DOBLE CARA EXCLUSIVA



100% COMPATÍVEL COM AS PRINCIPAIS MARCAS

WWF ANIMAL E AUTOCOLANTES

As peças FabBrix™ são feitas de madeira. Se colocadas dentro de água ou se houver muita humidade no ar, as peças podem perder ou alterar a função. Aviso importante: Devido às técnicas de corte de madeira de alta precisão, no início as peças podem ter um encaixe justo. Esta situação pode tornar mais difícil o processo de encaixe e desencaixe umas das outras. Ao fim de algumas utilizações, torna-se mais fácil. Não as molhe. Manter afastado da água e do fogo. **ATENÇÃO: PERIGO DE ASFIXIA - Peças pequenas.** Não aconselhável a crianças com idade inferior a 3 anos.

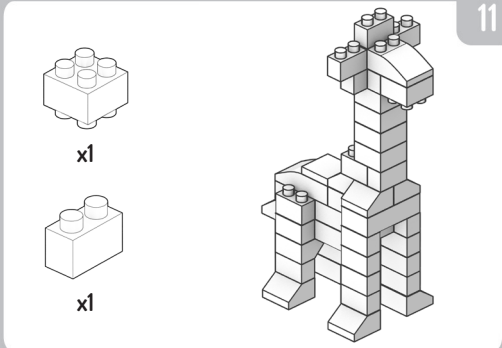
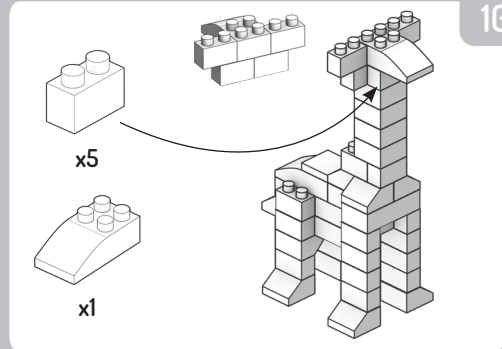
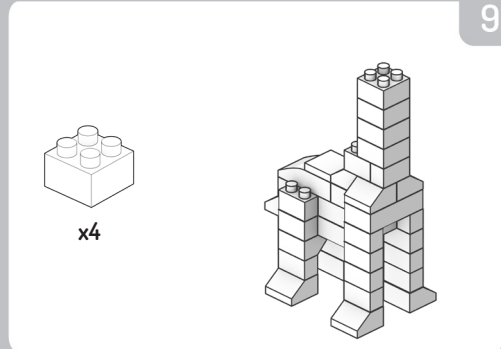
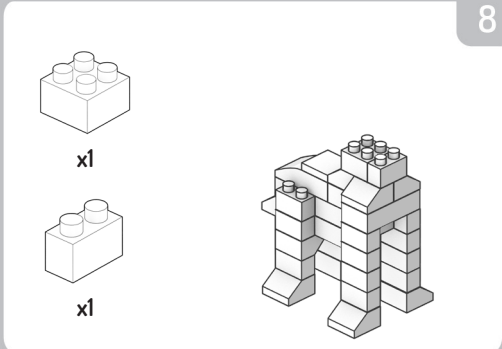
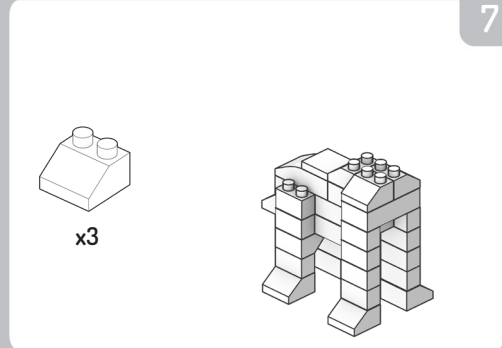
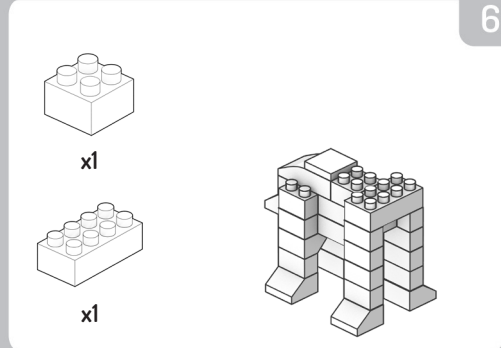
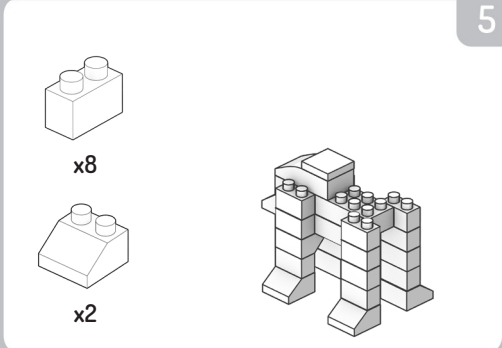
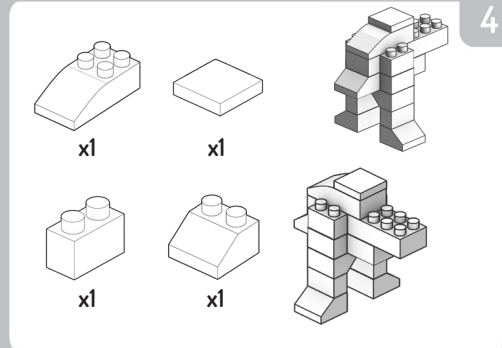
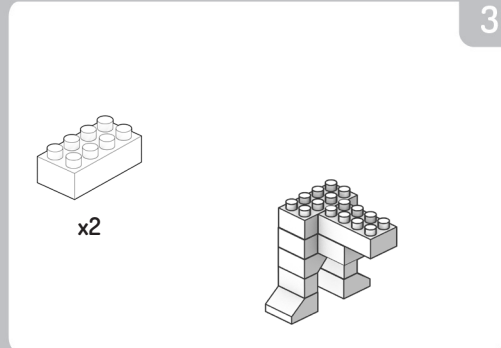
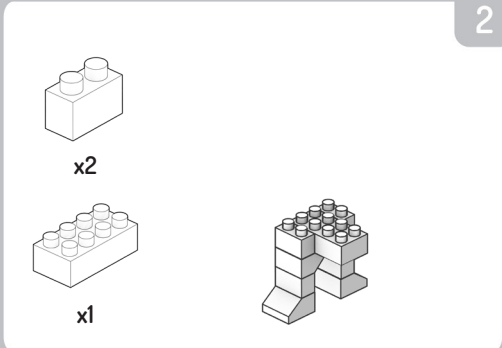
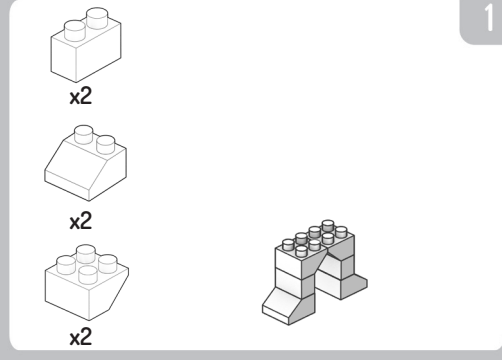
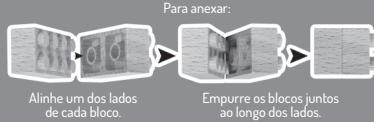

contact@loop-toys.com
 Loop Toys Ltd
 3/F, Jonsim Place, 228, Queen's Road East
 Wanchai - Hong Kong

Fabricado na China.
 © Loop Toys 2018. Todos os direitos reservados.
 Os logótipos FabBrix e Loop Toys são marcas registadas da Loop Toys.
EM CONFORMIDADE COM OS REQUISITOS DE SEGURANÇA DA ASTM F963 & EN71.
 Guarde esta caixa para referência futura.

